

E	REVISED ISSUE FOR DEVELOPMENT APPLICATION	AG	MD*	BM*	02.02.18	
D	REVISED ISSUE FOR DEVELOPMENT APPLICATION	AG	MD*	BM*	31.01.18	
C	ISSUED FOR DEVELOPMENT APPLICATION	AG	CS*	MW*	18.08.17	
B	ISSUED FOR DEVELOPMENT APPLICATION	KC	CS*	SM*	31.07.17	
A	ISSUED FOR REVIEW	KC	CS*	SM*	03.07.17	
No	Revision	Note: * indicates signatures on original issue of drawing or last revision of drawing	Drawn	Job Manager	Project Director	Date

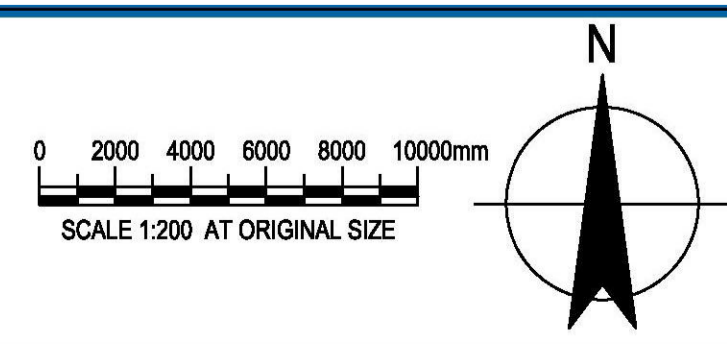

**GHDWOODHEAD**  
 Level 15, 133 Castlereagh Street, Sydney NSW 2000 Australia  
 T 61 2 9239 7100 F 61 2 9239 7199  
 E sydmill@ghd.com W www.ghd.com

**DO NOT SCALE**  
 GHD Pty Ltd  
 Conditions of Use.  
 This document may only be used by GHD's client (and any other person who GHD has agreed can use this document) for the purpose for which it was prepared and must not be used by any other person or for any other purpose.

Drawn	A.GOYAL	Designer	C.O'DOWD
Drafting Check	A.MACLEAN*	Design Check	L.ALLEN*
Approved (Project Director)	Date		
Scale	AS SHOWN		

This Drawing must not be used for construction unless signed as Approved

**DEVELOPMENT APPLICATION**

Client **NSW DEPARTMENT OF EDUCATION**  
 Project **CARLINGFORD PUBLIC SCHOOL REDEVELOPMENT**  
 Title **GENERAL LANDSCAPE ARRANGEMENT PLAN**  
 Original Size **A1** Drawing No: **21-26108-CF-DA-LA-0001** Rev: **E**



PLANTING SCHEDULE				
BOTANICAL NAME	COMMON NAME	POT SIZE	MATURE HEIGHT	QUANTITY
<b>TREES</b>				
T1 - BACKHOUSIA MYRTIFOLIA*	GREY MYRTLE	45 Ltr	8-10m	8
T2 - TRISTANIOPSIS LAURINA	WATER GUM	45 Ltr	8-10m	9
T3 - EUCALYPTUS TERETICORNIS	FOREST RED GUM	100 Ltr	15-17m	1
<b>T4 - COMPENSATORY TREES - 416m<sup>2</sup></b>				
ACACIA FLORIBUNDA*	SALLOW WATTLE	45 Ltr	6m	104
ACACIA IMPLEXA*	HICKORY	45 Ltr	5-10m	104
ALLOCASUARINA TORULOSA*	FOREST OAK	45 Ltr	15m	104
GLOCHIDION FERDINANDI VAR. FERDINANDI*	SMOOTH CHEESE TREE	45 Ltr	5-7m	104
<b>M1 - ENTRY PLANTING MIX - 486m<sup>2</sup></b>				
CAREX APPRESSA	TUSSOCK SEDGE	150mm	400mm	1458
DIANELLA CAERULEA*	BLUE FLAX LILY	150mm	2000mm	583
LEPTOSPERMUM TRINERVIUM*	FLAKY-BARKED TEA TREE	150mm	2000mm	292
MELALEUCA THYMIFOLIA	THYME HONEY MYRTLE	150mm	500mm	583
<b>M2 - SWALE PLANTING MIX - 69m<sup>2</sup></b>				
CAREX APPRESSA	TUSSOCK SEDGE	150mm	400mm	69
ISOLEPIS NODOSA	KNOBBY CLUB RUSH	75mm	500mm	138
JUNCUS USITATUS	MAT RUSH	75mm	400mm	138
<b>M3 - BATTER PLANTING MIX - 115m<sup>2</sup></b>				
CAREX APPRESSA	TUSSOCK SEDGE	150mm	400mm	92
HARDENBERGIA VIOLACEA	WINTER WHITE	75mm	1000mm	138
LEPTOSPERMUM TRINERVIUM*	FLAKY-BARKED TEA TREE	150mm	2000mm	92
LOMANDRA LONGIFOLIA*	SPINY MAT RUSH	75mm	1000mm	138
<b>M4 - BUSH REGENERATION UNDERSTORY PLANTING MIX - 1905m<sup>2</sup></b>				
ADIANTHUM AETHIOPICUM*	COMMON MAIDEN HAIR FERN	75mm	400mm	2286
DIANELLA CAERULEA*	BLUE FLAX LILY	75mm	500mm	3429
DICHONDRA REPENS*	KIDNEY WEED	75mm	100mm	2286
LOMANDRA LONGIFOLIA*	SPINY MAT RUSH	75mm	1000mm	3429

\* INDIGENOUS PLANTS

**T4 - COMPENSATORY TREE PLANTING MIX 1/m<sup>2</sup>**

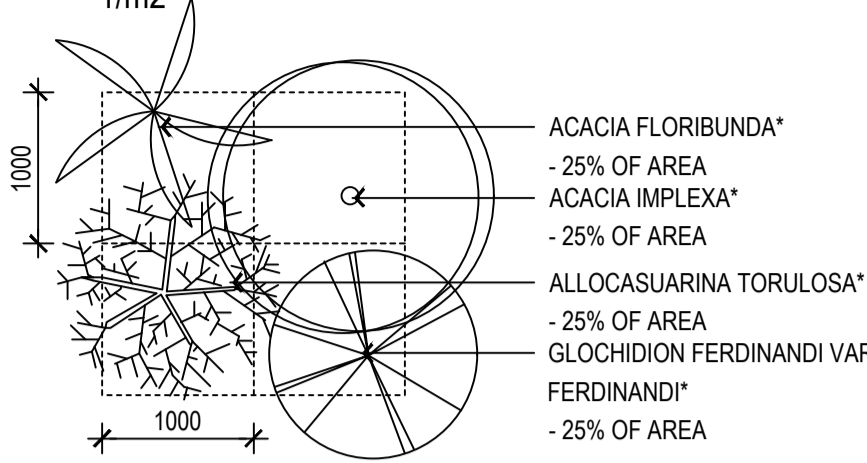

01 DETAIL

SCALE 1: 50

**M1 - ENTRY PLANTING MIX 6/m<sup>2</sup>**

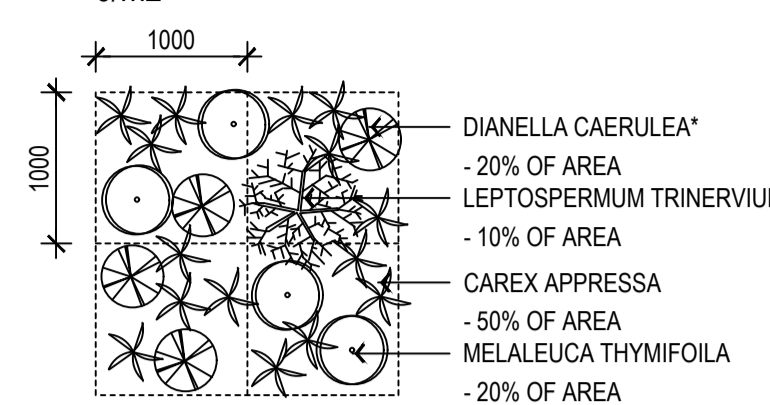

02 DETAIL

SCALE 1: 50

**M2 - SWALE PLANTING MIX 5/m<sup>2</sup>**

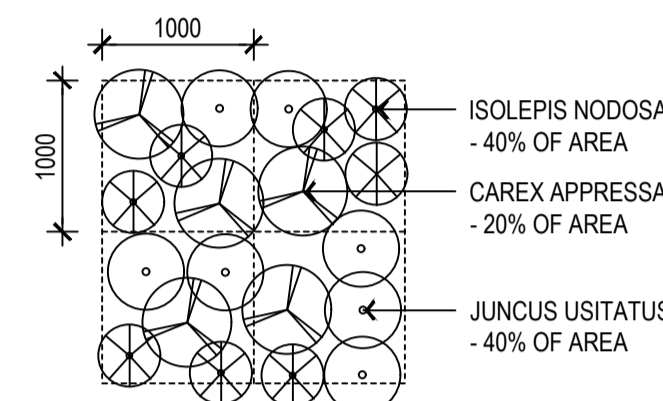

03 DETAIL

SCALE 1: 50

**M3 - BATTER PLANTING MIX 4/m<sup>2</sup>**

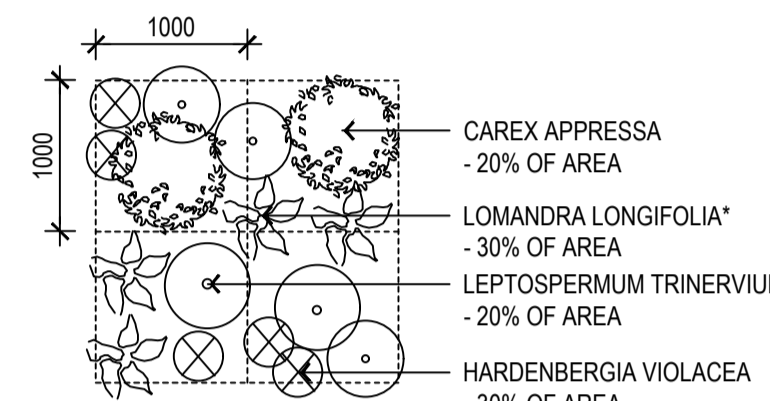

04 DETAIL

SCALE 1: 50

**M4 - BUSH REGENERATION UNDERSTORY PLANTING MIX 6/m<sup>2</sup>**

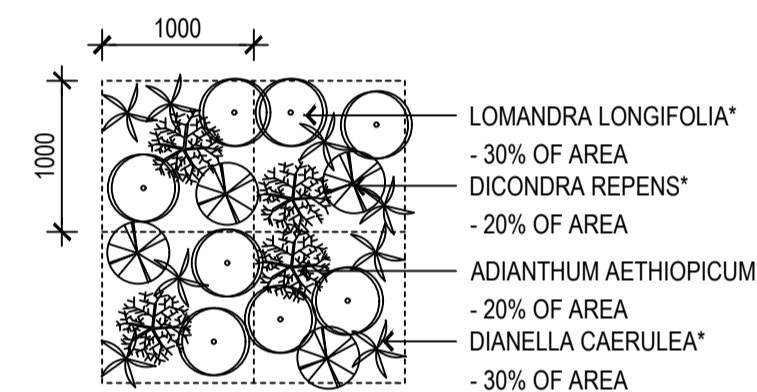

05 DETAIL

SCALE 1: 50



Isolepis nodosa  
Knobby Club Rush [M2]



Juncus usitatus  
Mat Rush [M2]



Lomandra longifolia  
Spiny Mat Rush [M3,M4]



Melaleuca thymifolia  
Thyme Honey Myrtle [M1]



Leptospermum trinervium  
Flaky-barked Tea Tree [M1,M3]

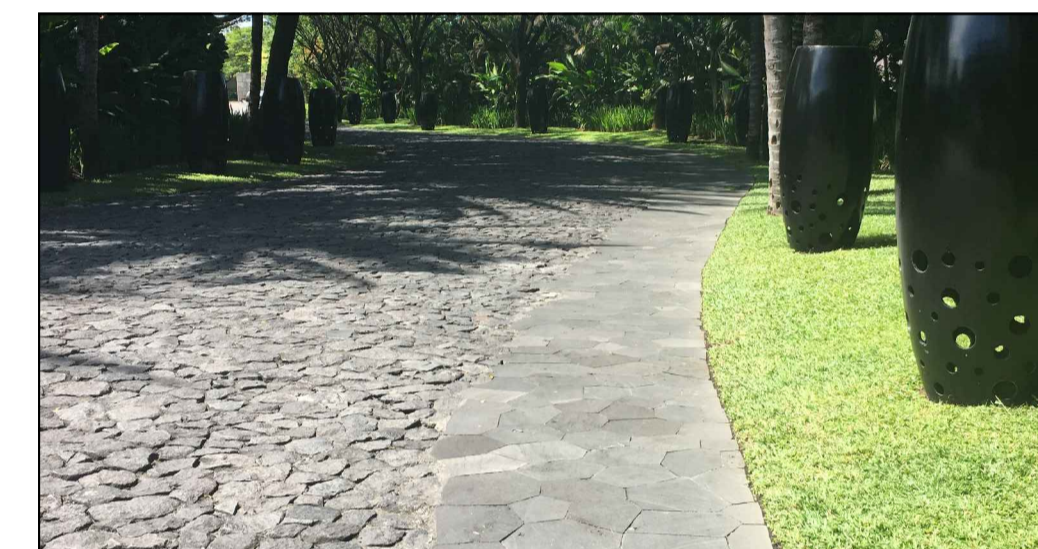

PAVING CONCEPT 1

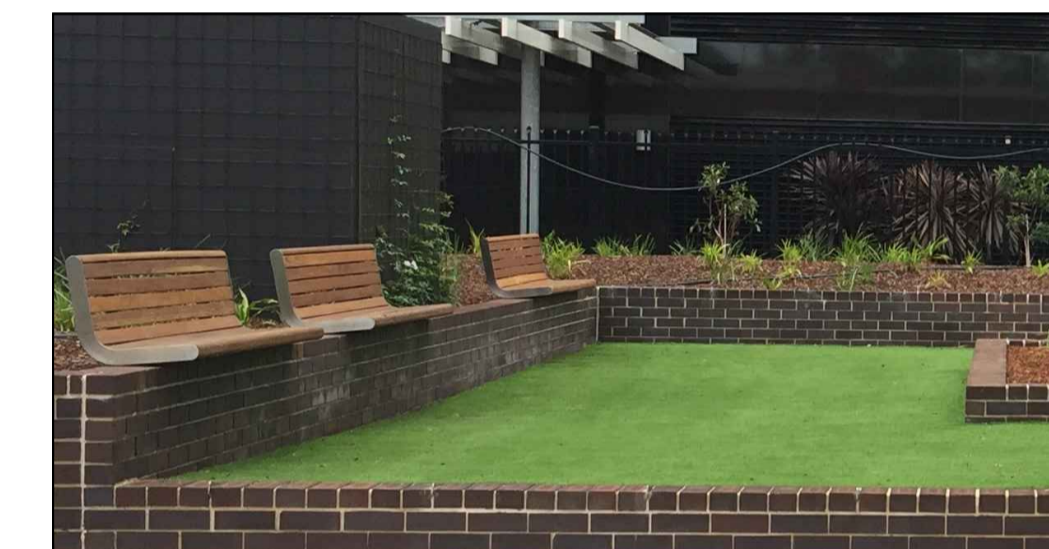

ASTRO TURF



Backhousia myrtifolia  
Grey Myrtle [T1]



Tristaniopsis laurina  
Water Gum [T2]



Eucalyptus tereticornis  
Forest red gum [T3]



Acacia implexa  
Hickory [T4]



Allocasuarina torulosa  
Forest Oak [T4]



Glochidion ferdinandi var. ferdinandi  
Smooth Cheese Tree [T4]



Adiantum aethiopicum  
Common Maiden Hair Fern [M4]



Carex appressa  
Tussock Sedge [T1]



Dianella caerulea  
Blue Flax Lily [M1,M2,M3]



Dichondra repens  
Kidney Weed [M4]



Hardenbergia violacea  
Winter White [M3]

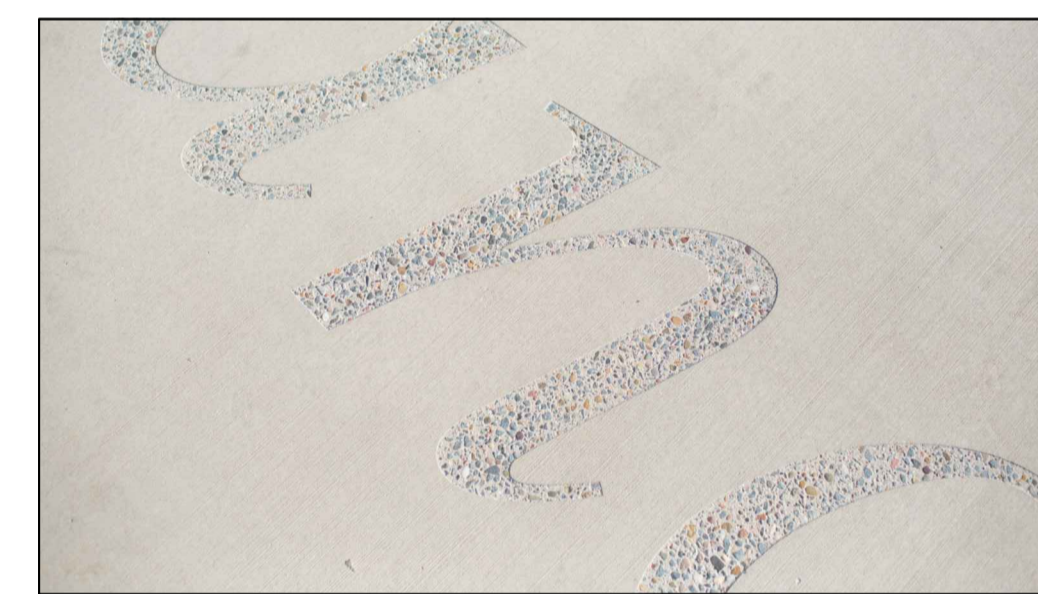

PAVING CONCEPT 2

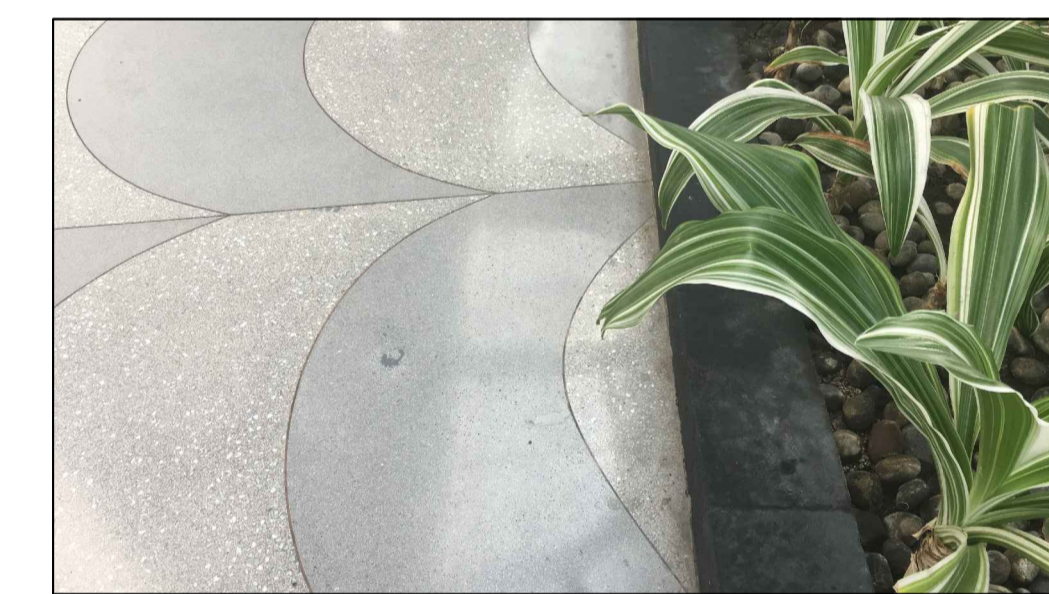

EXPOSED AGGREGATE CONCRETE FINISH



EXPOSED AGGREGATE



ASPHALT

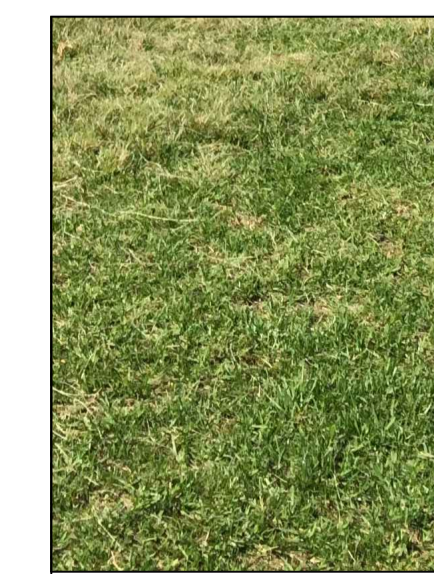

TURF

**DEVELOPMENT APPLICATION**

No	Revision	Note: * indicates signatures on original issue of drawing or last revision of drawing	Drawn	Job Manager	Project Director	Date
C	ISSUED FOR DEVELOPMENT APPLICATION		AG	CS*	MW*	18.08.17
B	ISSUED FOR DEVELOPMENT APPLICATION		KC	CS*	SM*	31.07.17
A	ISSUED FOR REVIEW		KC	CS*	SM*	03.07.17

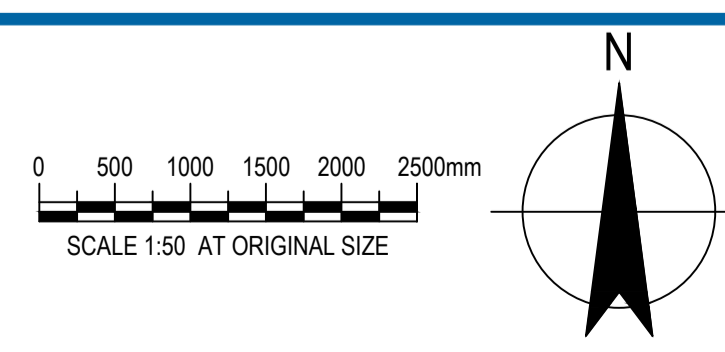

**GHDWOODHEAD**

Level 15, 133 Castlereagh Street, Sydney NSW 2000 Australia  
T 61 2 9239 7100 F 61 2 9239 7199  
E sydmail@ghd.com W www.ghd.com

DO NOT SCALE		Drawn	A.GOYAL	Designer	C.O'DOWD	Client	NSW DEPARTMENT OF EDUCATION
GHD Pty Ltd Conditions of Use. This document may only be used by GHD's client (and any other person who GHD has agreed can use this document) for the purpose for which it was prepared and must not be used by any other person or for any other purpose.	Drafting Check	A.MACLEAN*	Design Check	L.ALLEN*	Project	CARLINGFORD PUBLIC SCHOOL REDEVELOPMENT	
	Approved (Project Director) Date				Title	PLANTING SCHEDULE	
	Scale	AS SHOWN	This Drawing must not be used for Construction unless signed as Approved		Original Size	A1	Drawing No: 21-26108-CF-DA-LA-0002
							Rev: C



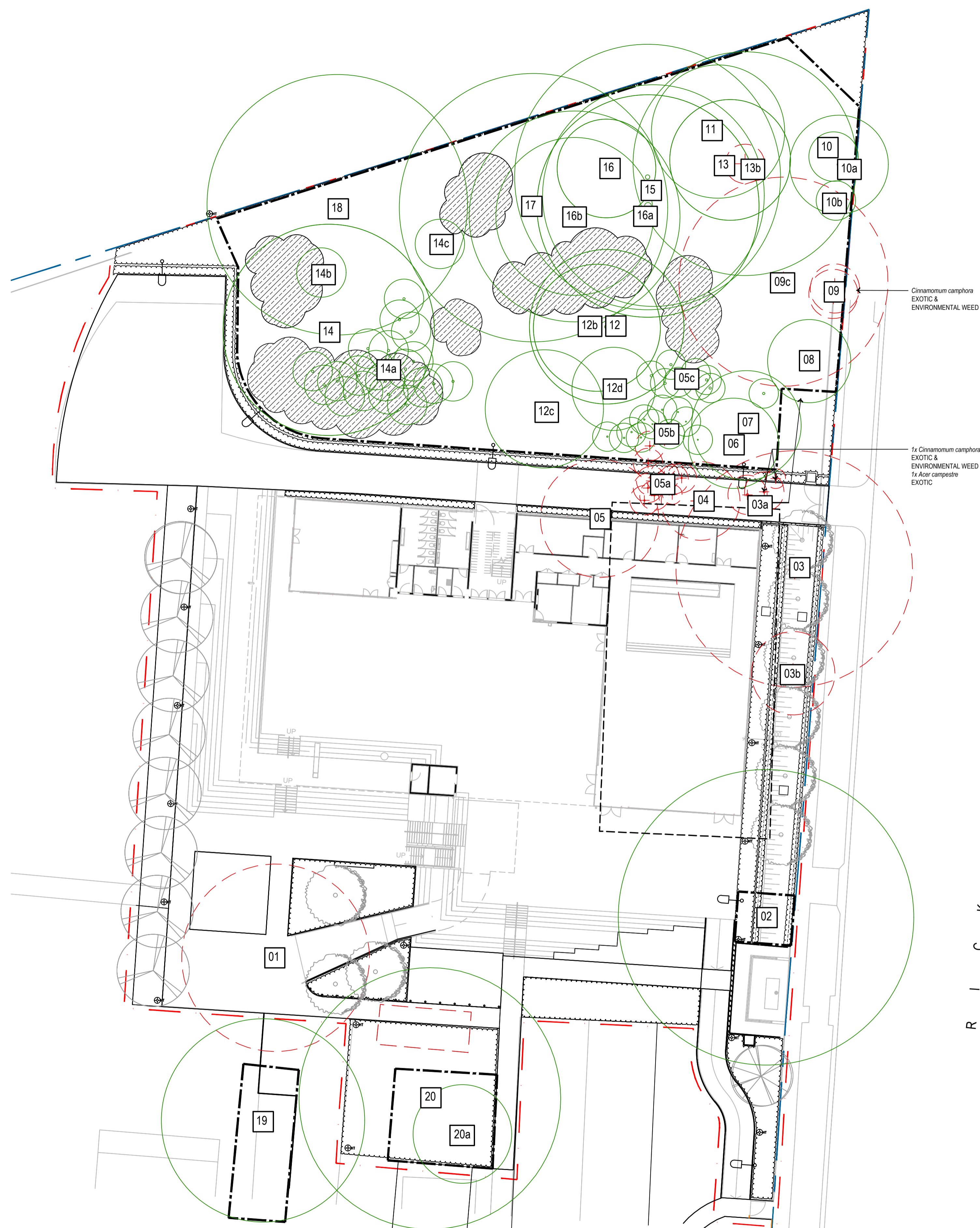

R I C K A R D S T R E E T



KEY PLAN  
N.T.S

**LEGEND**

- PREPARATION
- - - EXISTING SITE BOUNDARY FENCE
  - - - EXTENT OF LANDSCAPE WORKS
  - (+ in red circle) EXISTING TREE TO BE REMOVED
  - (o in green circle) EXISTING TREE TO BE RETAINED
  - (circle with cross) PROPOSED TREE PLANTING, T1
  - (circle with dot) PROPOSED TREE PLANTING, T2
  - (circle with star) PROPOSED FEATURE TREE, T3
  - (shaded circle) PROPOSED COMPENSATORY PLANTING, T4
  - - - TREE PROTECTION ZONE FENCE

NOTE: REFER TO ARBORICULTURE TREE MANAGEMENT PLAN FOR TREE SPECIES AND TREE PROTECTION FENCE DETAILS.

**DEVELOPMENT APPLICATION**

C	REVISED ISSUE FOR DEVELOPMENT APPLICATION	CBM	MD*	BM*	09.03.18	
B	REVISED ISSUE FOR DEVELOPMENT APPLICATION	AG	MD*	BM*	02.02.18	
A	REVISED ISSUE FOR DEVELOPMENT APPLICATION	AG	MD*	BM*	31.01.18	
No	Revision	Note: * indicates signatures on original issue of drawing or last revision of drawing	Drawn	Job Manager	Project Director	Date

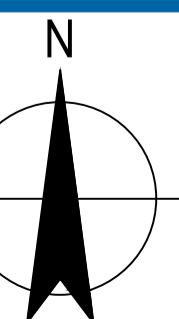

**GHDWOODHEAD**

Level 15, 133 Castlereagh Street, Sydney NSW 2000 Australia  
T 61 2 9239 7100 F 61 2 9239 7199  
E sydmall@ghd.com W www.ghd.com

**DO NOT SCALE**

GHD Pty Ltd  
Conditions of Use.  
This document may only be used by GHD's client (and any other person who GHD has agreed can use this document) for the purpose for which it was prepared and must not be used by any other person or for any other purpose.

Drawn	A.GOYAL	Designer	C.O'DOWD
Drafting Check	A.MACLEAN*	Design Check	L.ALLEN*
Approved (Project Director)	Date		
Scale	1:250	This Drawing must not be used for Construction unless signed as Approved	

Client	NSW DEPARTMENT OF EDUCATION		
Project	CARLINGFORD PUBLIC SCHOOL REDEVELOPMENT		
Title	TREE REMOVAL PLAN		
Original Size	A1	Drawing No:	21-26108-CF-DA-LA-0003
Rev:	C		



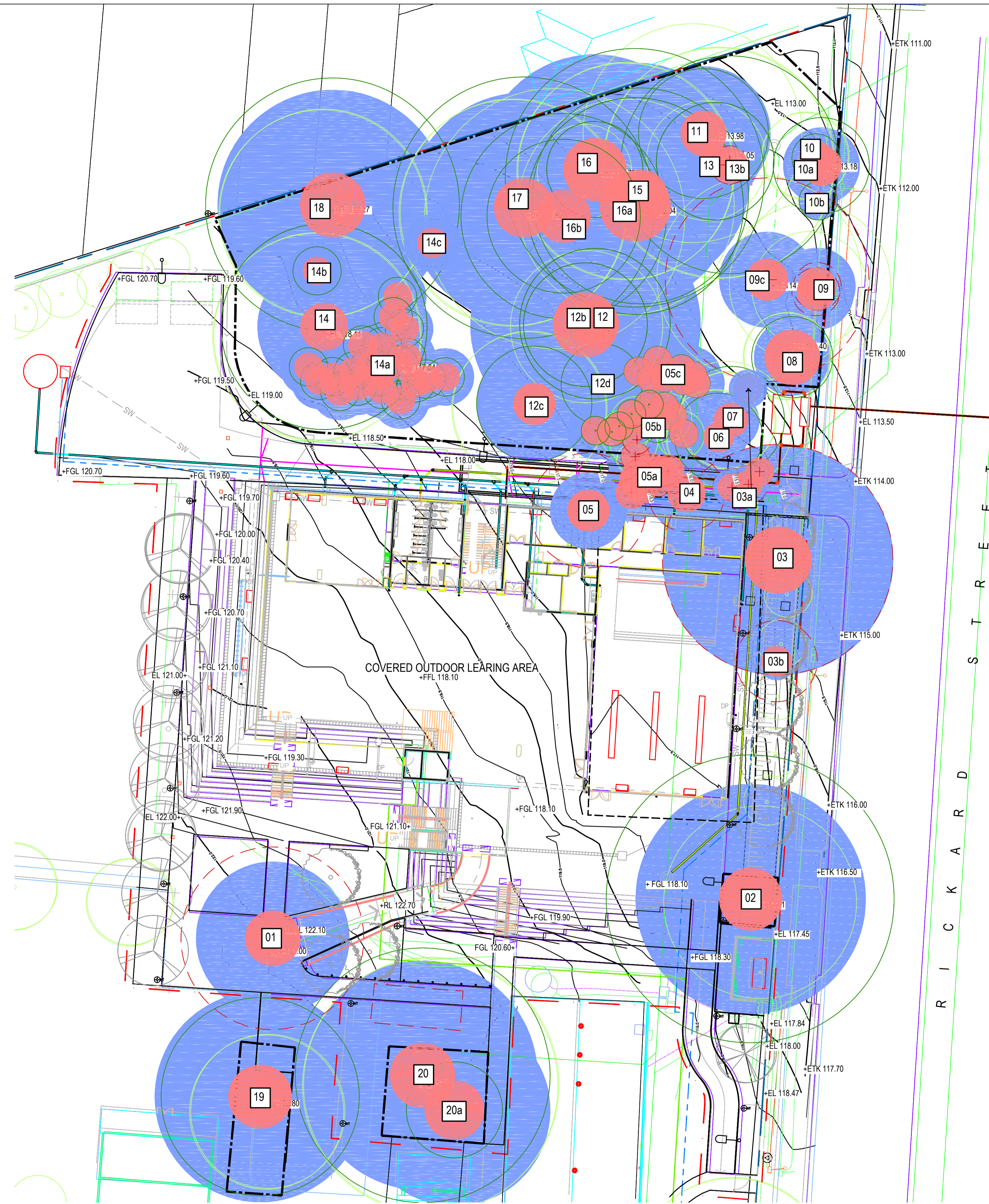

- LEGEND**
- PREPARATION
  - EXISTING SITE BOUNDARY FENCE
  - EXTENT OF LANDSCAPE WORKS
  - EXISTING TREE TO BE REMOVED
  - EXISTING TREE TO BE RETAINED
  - PROPOSED TREE PLANTING, T1
  - PROPOSED TREE PLANTING, T2
  - PROPOSED FEATURE TREE, T3
  - PROPOSED COMPENSATORY PLANTING, T4
  - TREE PROTECTION ZONE FENCE
  - TREE PROTECTION ZONE (TPZ)
  - STRUCTURAL ROOT ZONE (SRZ)

NOTE: REFER TO ARBORICULTURE TREE MANAGEMENT PLAN FOR TREE SPECIES AND TREE PROTECTION FENCE DETAILS.

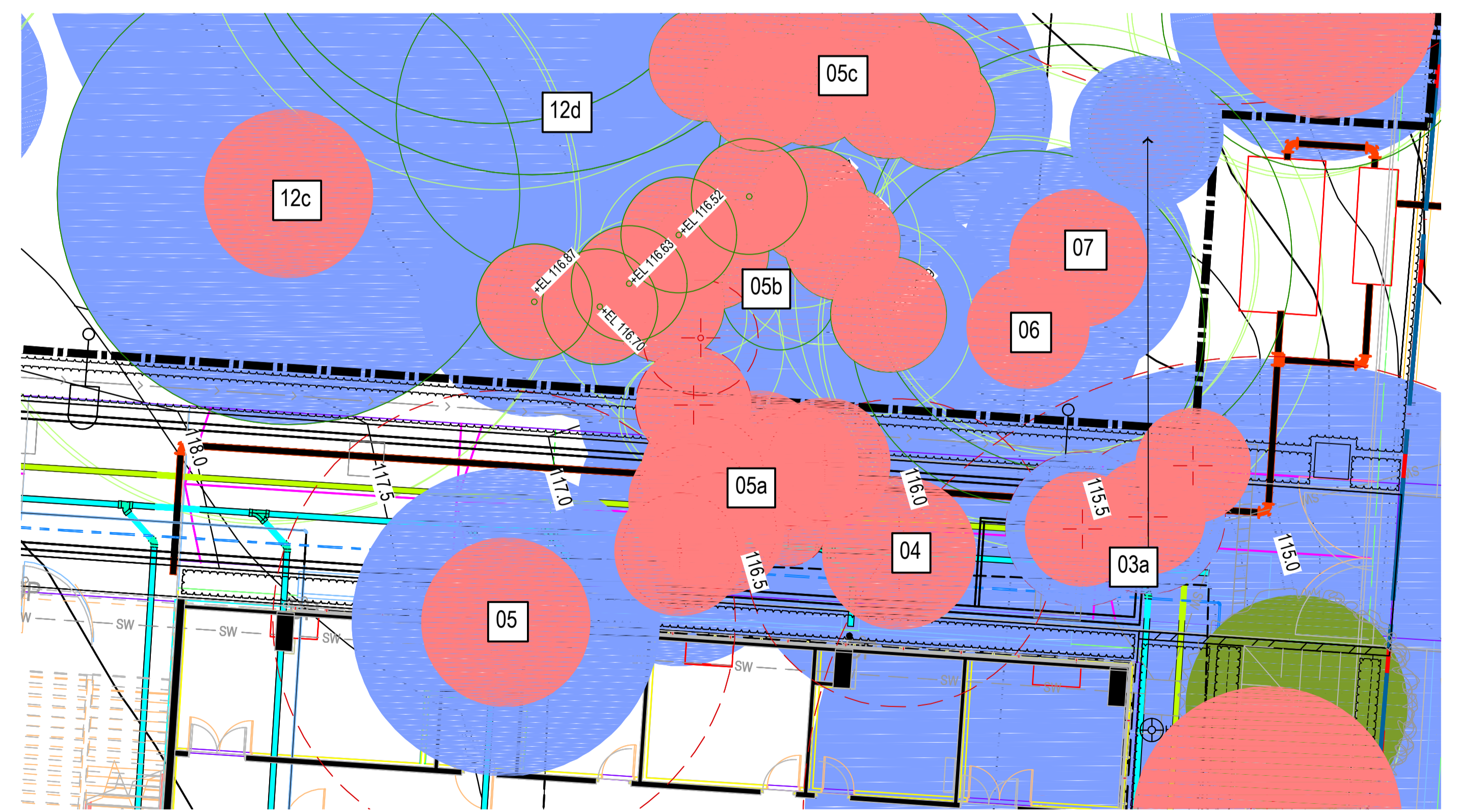

DETAIL PLAN  
1:100

**DEVELOPMENT APPLICATION**

No	Revision	Note: * indicates signatures on original issue of drawing or last revision of drawing	Drawn	Job Manager	Project Director	Date
A	REVISED ISSUE FOR DEVELOPMENT APPLICATION		AG	MD*	BM*	09.03.18

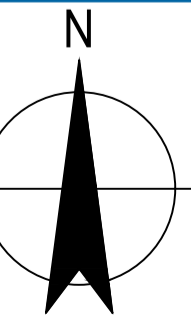
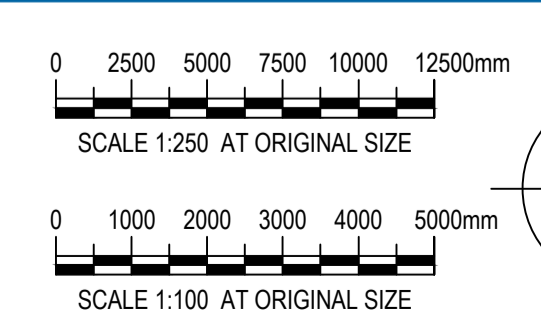

**GHDWOODHEAD**  
Level 15, 133 Castlereagh Street, Sydney NSW 2000 Australia  
T 61 2 9239 7100 F 61 2 9239 7199  
E sydmall@ghd.com W www.ghd.com

**DO NOT SCALE**  
GHD Pty Ltd  
Conditions of Use:  
This document may only be used by GHD's client (and any other person who GHD has agreed can use this document) for the purpose for which it was prepared and must not be used by any other person or for any other purpose.

Drawn	C.B-MATHIESON	Designer	C.O'DOWD
Drafting Check		Design Check	L.ALLEN*
Approved (Project Director)		Date	
Scale	1:250	This Drawing must not be used for Construction unless signed as Approved	

Client	NSW DEPARTMENT OF EDUCATION		
Project	CARLINGFORD PUBLIC SCHOOL REDEVELOPMENT		
Title	TREE PROTECTION PLAN		
Original Size	A1	Drawing No:	21-26108-CF-DA-LA-0004
Rev:	A		